

Schema MensajeReceptor.xsd

schema location: <e:\Documents\NetBeansProjects\Ministerio de Hacienda\xml-schemas\MensajeReceptor.xsd>
attributeFormDefault: **unqualified**
elementFormDefault: **qualified**
targetNamespace: <https://www.hacienda.go.cr/ATV/docs/esquemas/2016/v4.1/mensajeReceptor>

Elements

[MensajeReceptor](#)

schema location: <C:\Program Files\Altova\Common2017\Schemas\xmlsig\files\xmlsig-core-schema.xsd>
attributeFormDefault:
elementFormDefault: **qualified**
targetNamespace: <http://www.w3.org/2000/09/xmlsig#>

Elements

[CanonicalizationMethod](#)

[DigestMethod](#)

[DigestValue](#)

[DSAKeyValue](#)

[KeyInfo](#)

[KeyName](#)

[KeyValue](#)

[Manifest](#)

[MgmtData](#)

[Object](#)

[PGPData](#)

[Reference](#)

[RetrievalMethod](#)

[RSAKeyValue](#)

[Signature](#)

[SignatureMethod](#)

[SignatureProperties](#)

[SignatureProperty](#)

[SignatureValue](#)

[SignedInfo](#)

[SPKIData](#)

[Transform](#)

[Transforms](#)

[X509Data](#)

Complex types

[CanonicalizationMethodType](#)

[DigestMethodType](#)

[DSAKeyValueType](#)

[KeyInfoType](#)

[KeyValueType](#)

[ManifestType](#)

[ObjectType](#)

[PGPDataType](#)

[ReferenceType](#)

[RetrievalMethodType](#)

[RSAKeyValueType](#)

[SignatureMethodType](#)

[SignaturePropertiesType](#)

[SignaturePropertyType](#)

[SignatureType](#)

[SignatureValueType](#)

[SignedInfoType](#)

[SPKIDataType](#)

[TransformsType](#)

[TransformType](#)

[X509DataType](#)

[X509IssuerSerialType](#)

Simple types

[CryptoBinary](#)

[DigestValueType](#)

[HMACOutputLengthType](#)

element **MensajeReceptor**

<p>diagram</p>	
<p>namespace</p>	<p>https://www.hacienda.go.cr/ATV/docs/esquemas/2016/v4.1/mensajeReceptor</p>
<p>properties</p>	<p>content complex</p>
<p>children</p>	<p>Clave NumeroCedulaEmisor FechaEmisionDoc Mensaje DetalleMensaje MontoTotalImpuesto TotalFactura NumeroCedulaReceptor NumeroConsecutivoReceptor ds:Signature</p>
<p>annotation</p>	<p>documentation Mensaje de aceptacion o rechazo de los documentos electronicos por parte del obligado tributario</p>
<p>source</p>	<pre><xs:element name="MensajeReceptor"> <xs:annotation> <xs:documentation>Mensaje de aceptacion o rechazo de los documentos electronicos por parte del obligado tributario</xs:documentation> </xs:annotation> <xs:complexType></pre>

```

<xs:sequence>
  <xs:element name="Clave">
    <xs:annotation>
      <xs:documentation>Clave numérica del comprobante</xs:documentation>
    </xs:annotation>
    <xs:simpleType>
      <xs:restriction base="xs:string">
        <xs:pattern value="\d{50,50}"/>
      </xs:restriction>
    </xs:simpleType>
  </xs:element>
  <xs:element name="NumeroCedulaEmisor">
    <xs:annotation>
      <xs:documentation>Número de cédula física/jurídica/NITE/DIMEX del
vendedor</xs:documentation>
    </xs:annotation>
    <xs:simpleType>
      <xs:restriction base="xs:string">
        <xs:pattern value="\d{12,12}"/>
      </xs:restriction>
    </xs:simpleType>
  </xs:element>
  <xs:element name="FechaEmisionDoc" type="xs:dateTime">
    <xs:annotation>
      <xs:documentation>Fecha de emision de la
confirmación</xs:documentation>
    </xs:annotation>
  </xs:element>
  <xs:element name="Mensaje">
    <xs:annotation>
      <xs:documentation>Codigo del mensaje de respuesta. 1 aceptado, 2
aceptado parcialmente, 3 rechazado</xs:documentation>
    </xs:annotation>
    <xs:simpleType>
      <xs:restriction base="xs:integer">
        <xs:enumeration value="1">
          <xs:annotation>
            <xs:documentation>Aceptado</xs:documentation>
          </xs:annotation>
        </xs:enumeration>
        <xs:enumeration value="2">
          <xs:annotation>
            <xs:documentation>Aceptado Parcialmente</xs:documentation>
          </xs:annotation>
        </xs:enumeration>
        <xs:enumeration value="3">
          <xs:annotation>
            <xs:documentation>Rechazado</xs:documentation>
          </xs:annotation>
        </xs:enumeration>
      </xs:restriction>
    </xs:simpleType>
  </xs:element>
  <xs:element name="DetalleMensaje" minOccurs="0">
    <xs:annotation>

```

```

    <xs:documentation>Detalle del mensaje</xs:documentation>
  </xs:annotation>
  <xs:simpleType>
    <xs:restriction base="xs:string">
      <xs:maxLength value="80"/>
    </xs:restriction>
  </xs:simpleType>
</xs:element>
<xs:element name="MontoTotalImpuesto" minOccurs="0">
  <xs:annotation>
    <xs:documentation>Monto total del impuesto, que es obligatorio si el
comprobante tenga impuesto.</xs:documentation>
  </xs:annotation>
  <xs:simpleType>
    <xs:restriction base="xs:decimal">
      <xs:totalDigits value="18"/>
      <xs:fractionDigits value="5"/>
    </xs:restriction>
  </xs:simpleType>
</xs:element>
<xs:element name="TotalFactura">
  <xs:annotation>
    <xs:documentation>Monto total de la factura</xs:documentation>
  </xs:annotation>
  <xs:simpleType>
    <xs:restriction base="xs:decimal">
      <xs:totalDigits value="18"/>
      <xs:fractionDigits value="5"/>
    </xs:restriction>
  </xs:simpleType>
</xs:element>
<xs:element name="NumeroCedulaReceptor">
  <xs:annotation>
    <xs:documentation>Número de cédula física/jurídica/NITE/DIMEX del
comprador</xs:documentation>
  </xs:annotation>
  <xs:simpleType>
    <xs:restriction base="xs:string">
      <xs:pattern value="\d{12,12}"/>
    </xs:restriction>
  </xs:simpleType>
</xs:element>
<xs:element name="NumeroConsecutivoReceptor">
  <xs:annotation>
    <xs:documentation>Numeración consecutiva de los mensajes de
confirmación</xs:documentation>
  </xs:annotation>
  <xs:simpleType>
    <xs:restriction base="xs:string">
      <xs:pattern value="\d{20,20}"/>
    </xs:restriction>
  </xs:simpleType>
</xs:element>
<xs:element ref="ds:Signature" minOccurs="1" maxOccurs="1"/>
</xs:sequence>

```

	<pre></xs:complexType> </xs:element></pre>
--	--

element MensajeReceptor/Clave

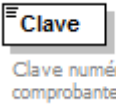
diagram							
namespace	https://www.hacienda.go.cr/ATV/docs/esquemas/2016/v4.1/mensajeReceptor						
type	restriction of xs:string						
properties	content simple						
facets	<table border="1"> <thead> <tr> <th>Kind</th> <th>Value</th> <th>Annotation</th> </tr> </thead> <tbody> <tr> <td>pattern</td> <td>\d{50,50}</td> <td></td> </tr> </tbody> </table>	Kind	Value	Annotation	pattern	\d{50,50}	
Kind	Value	Annotation					
pattern	\d{50,50}						
annotation	documentation Clave numérica del comprobante						
source	<pre><xs:element name="Clave"> <xs:annotation> <xs:documentation>Clave numérica del comprobante</xs:documentation> </xs:annotation> <xs:simpleType> <xs:restriction base="xs:string"> <xs:pattern value="\d{50,50}"/> </xs:restriction> </xs:simpleType> </xs:element></pre>						

element MensajeReceptor/NumeroCedulaEmisor

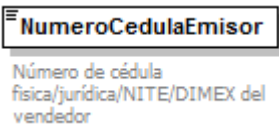
diagram							
namespace	https://www.hacienda.go.cr/ATV/docs/esquemas/2016/v4.1/mensajeReceptor						
type	restriction of xs:string						
properties	content simple						
facets	<table border="1"> <thead> <tr> <th>Kind</th> <th>Value</th> <th>Annotation</th> </tr> </thead> <tbody> <tr> <td>pattern</td> <td>\d{12,12}</td> <td></td> </tr> </tbody> </table>	Kind	Value	Annotation	pattern	\d{12,12}	
Kind	Value	Annotation					
pattern	\d{12,12}						
annotation	documentation Número de cédula física/jurídica/NITE/DIMEX del vendedor						
source	<pre><xs:element name="NumeroCedulaEmisor"> <xs:annotation> <xs:documentation>Número de cédula física/jurídica/NITE/DIMEX del vendedor</xs:documentation> </xs:annotation> <xs:simpleType> <xs:restriction base="xs:string"> <xs:pattern value="\d{12,12}"/> </xs:restriction> </xs:element></pre>						

	<pre> </xs:simpleType> </xs:element> </pre>
--	---

element MensajeReceptor/FechaEmisionDoc

diagram	 <p>Fecha de emision de la confirmación</p>
namespace	https://www.hacienda.go.cr/ATV/docs/esquemas/2016/v4.1/mensajeReceptor
type	xs:dateTime
properties	content simple
annotation	documentation Fecha de emision de la confirmación
source	<pre> <xs:element name="FechaEmisionDoc" type="xs:dateTime"> <xs:annotation> <xs:documentation>Fecha de emision de la confirmación</xs:documentation> </xs:annotation> </xs:element> </pre>

element MensajeReceptor/Mensaje

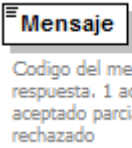
diagram	 <p>Codigo del mensaje de respuesta. 1 aceptado, 2 aceptado parcialmente, 3 rechazado</p>												
namespace	https://www.hacienda.go.cr/ATV/docs/esquemas/2016/v4.1/mensajeReceptor												
type	restriction of xs:integer												
properties	content simple												
facets	<table border="1"> <thead> <tr> <th>Kind</th> <th>Value</th> <th>Annotation</th> </tr> </thead> <tbody> <tr> <td>enumeration</td> <td>1</td> <td>documentation Aceptado</td> </tr> <tr> <td>enumeration</td> <td>2</td> <td>documentation Aceptado Parcialmente</td> </tr> <tr> <td>enumeration</td> <td>3</td> <td>documentation Rechazado</td> </tr> </tbody> </table>	Kind	Value	Annotation	enumeration	1	documentation Aceptado	enumeration	2	documentation Aceptado Parcialmente	enumeration	3	documentation Rechazado
Kind	Value	Annotation											
enumeration	1	documentation Aceptado											
enumeration	2	documentation Aceptado Parcialmente											
enumeration	3	documentation Rechazado											
annotation	documentation Codigo del mensaje de respuesta. 1 aceptado, 2 aceptado parcialmente, 3 rechazado												
source	<pre> <xs:element name="Mensaje"> <xs:annotation> <xs:documentation>Codigo del mensaje de respuesta. 1 aceptado, 2 aceptado parcialmente, 3 rechazado</xs:documentation> </xs:annotation> <xs:simpleType> <xs:restriction base="xs:integer"> <xs:enumeration value="1"> <xs:annotation> <xs:documentation>Aceptado</xs:documentation> </xs:annotation> </xs:enumeration> </pre>												

	<pre> <xs:enumeration value="2"> <xs:annotation> <xs:documentation>Aceptado Parcialmente</xs:documentation> </xs:annotation> </xs:enumeration> <xs:enumeration value="3"> <xs:annotation> <xs:documentation>Rechazado</xs:documentation> </xs:annotation> </xs:enumeration> </xs:restriction> </xs:simpleType> </xs:element> </pre>
--	---

element **MensajeReceptor/DetalleMensaje**

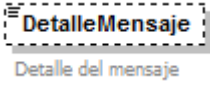
diagram	
namespace	https://www.hacienda.go.cr/ATV/docs/esquemas/2016/v4.1/mensajeReceptor
type	restriction of xs:string
properties	minOcc 0 maxOcc 1 content simple
facets	Kind Value Annotation maxLength 80
annotation	documentation Detalle del mensaje
source	<pre> <xs:element name="DetalleMensaje" minOccurs="0"> <xs:annotation> <xs:documentation>Detalle del mensaje</xs:documentation> </xs:annotation> <xs:simpleType> <xs:restriction base="xs:string"> <xs:maxLength value="80"/> </xs:restriction> </xs:simpleType> </xs:element> </pre>

element **MensajeReceptor/MontoTotalImpuesto**

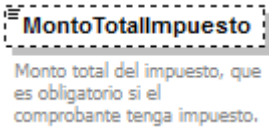
diagram	
namespace	https://www.hacienda.go.cr/ATV/docs/esquemas/2016/v4.1/mensajeReceptor
type	restriction of xs:decimal
properties	minOcc 0 maxOcc 1 content simple

facets	<table border="1"> <thead> <tr> <th>Kind</th> <th>Value</th> <th>Annotation</th> </tr> </thead> <tbody> <tr> <td>totalDigits</td> <td>18</td> <td></td> </tr> <tr> <td>fractionDigits</td> <td>5</td> <td></td> </tr> </tbody> </table>	Kind	Value	Annotation	totalDigits	18		fractionDigits	5	
Kind	Value	Annotation								
totalDigits	18									
fractionDigits	5									
annotation	documentation Monto total del impuesto, que es obligatorio si el comprobante tenga impuesto.									
source	<pre><xs:element name="MontoTotalImpuesto" minOccurs="0"> <xs:annotation> <xs:documentation>Monto total del impuesto, que es obligatorio si el comprobante tenga impuesto.</xs:documentation> </xs:annotation> <xs:simpleType> <xs:restriction base="xs:decimal"> <xs:totalDigits value="18"/> <xs:fractionDigits value="5"/> </xs:restriction> </xs:simpleType> </xs:element></pre>									

element MensajeReceptor/TotalFactura

diagram										
namespace	https://www.hacienda.go.cr/ATV/docs/esquemas/2016/v4.1/mensajeReceptor									
type	restriction of xs:decimal									
properties	content simple									
facets	<table border="1"> <thead> <tr> <th>Kind</th> <th>Value</th> <th>Annotation</th> </tr> </thead> <tbody> <tr> <td>totalDigits</td> <td>18</td> <td></td> </tr> <tr> <td>fractionDigits</td> <td>5</td> <td></td> </tr> </tbody> </table>	Kind	Value	Annotation	totalDigits	18		fractionDigits	5	
Kind	Value	Annotation								
totalDigits	18									
fractionDigits	5									
annotation	documentation Monto total de la factura									
source	<pre><xs:element name="TotalFactura"> <xs:annotation> <xs:documentation>Monto total de la factura</xs:documentation> </xs:annotation> <xs:simpleType> <xs:restriction base="xs:decimal"> <xs:totalDigits value="18"/> <xs:fractionDigits value="5"/> </xs:restriction> </xs:simpleType> </xs:element></pre>									

element MensajeReceptor/NumeroCedulaReceptor

diagram	
---------	---

namespace	https://www.hacienda.go.cr/ATV/docs/esquemas/2016/v4.1/mensajeReceptor						
type	restriction of xs:string						
properties	content simple						
facets	<table border="1"> <thead> <tr> <th>Kind</th> <th>Value</th> <th>Annotation</th> </tr> </thead> <tbody> <tr> <td>pattern</td> <td>\d{12,12}</td> <td></td> </tr> </tbody> </table>	Kind	Value	Annotation	pattern	\d{12,12}	
Kind	Value	Annotation					
pattern	\d{12,12}						
annotation	documentation Número de cédula física/jurídica/NITE/DIMEX del comprador						
source	<pre> <xs:element name="NumeroCedulaReceptor"> <xs:annotation> <xs:documentation>Número de cédula física/jurídica/NITE/DIMEX del comprador</xs:documentation> </xs:annotation> <xs:simpleType> <xs:restriction base="xs:string"> <xs:pattern value="\d{12,12}"/> </xs:restriction> </xs:simpleType> </xs:element> </pre>						

element MensajeReceptor/NumeroConsecutivoReceptor

diagram							
namespace	https://www.hacienda.go.cr/ATV/docs/esquemas/2016/v4.1/mensajeReceptor						
type	restriction of xs:string						
properties	content simple						
facets	<table border="1"> <thead> <tr> <th>Kind</th> <th>Value</th> <th>Annotation</th> </tr> </thead> <tbody> <tr> <td>pattern</td> <td>\d{20,20}</td> <td></td> </tr> </tbody> </table>	Kind	Value	Annotation	pattern	\d{20,20}	
Kind	Value	Annotation					
pattern	\d{20,20}						
annotation	documentation Numeración consecutiva de los mensajes de confirmación						
source	<pre> <xs:element name="NumeroConsecutivoReceptor"> <xs:annotation> <xs:documentation>Numeración consecutiva de los mensajes de confirmación</xs:documentation> </xs:annotation> <xs:simpleType> <xs:restriction base="xs:string"> <xs:pattern value="\d{20,20}"/> </xs:restriction> </xs:simpleType> </xs:element> </pre>						

element CanonicalizationMethod

diagram						
namespace	http://www.w3.org/2000/09/xmldsig#					
type	ds:CanonicalizationMethodType					
properties	content	complex				
	mixed	true				
used by	complexType	SignedInfoType				
attributes	Name	Type	Use	Default	Fixed	Annotation
	Algorithm	xs:anyURI	required			
source	<pre><xs:element name="CanonicalizationMethod" type="ds:CanonicalizationMethodType"/></pre>					

element DigestMethod

diagram						
namespace	http://www.w3.org/2000/09/xmldsig#					
type	ds:DigestMethodType					
properties	content	complex				
	mixed	true				
used by	complexType	ReferenceType				
attributes	Name	Type	Use	Default	Fixed	Annotation
	Algorithm	xs:anyURI	required			
source	<pre><xs:element name="DigestMethod" type="ds:DigestMethodType"/></pre>					

element DigestValue

diagram						
---------	--	--	--	--	--	--

namespace	http://www.w3.org/2000/09/xmldsig#
type	ds:DigestValueType
properties	content simple
used by	complexType ReferenceType
source	<code><xs:element name="DigestValue" type="ds:DigestValueType"/></code>

element DSAKeyValue

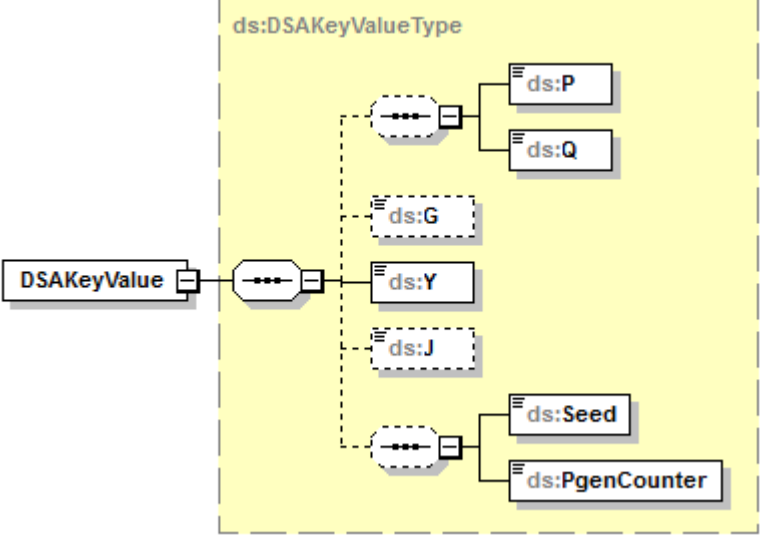
diagram	 <p>The diagram illustrates the structure of the <code>ds:DSAKeyValue</code> element. It is a complex type containing several child elements. The root element is <code>DSAKeyValue</code>, which is connected to a central node. This central node branches into two main paths. The upper path contains a dashed box labeled <code>ds:G</code>, which is connected to a node that branches into <code>ds:P</code> and <code>ds:Q</code>. The lower path contains a dashed box labeled <code>ds:Y</code>, which is connected to a node that branches into <code>ds:J</code> and another node. This second node branches into <code>ds:Seed</code> and <code>ds:PgenCounter</code>. The entire structure is enclosed in a dashed box labeled <code>ds:DSAKeyValue Type</code>.</p>
namespace	http://www.w3.org/2000/09/xmldsig#
type	ds:DSAKeyValue
properties	content complex
children	ds:P ds:Q ds:G ds:Y ds:J ds:Seed ds:PgenCounter
used by	complexType KeyValue
source	<code><xs:element name="DSAKeyValue" type="ds:DSAKeyValue"/></code>

element **KeyInfo**

diagram						
namespace	http://www.w3.org/2000/09/xmldsig#					
type	ds:KeyInfoType					
properties	content	mixed	complex	true		
children	ds:KeyName ds:KeyValue ds:RetrievalMethod ds:X509Data ds:PGPData ds:SPKIData ds:MgmtData					
used by	complexType	SignatureType				
attributes	Name	Type	Use	Default	Fixed	Annotation
	Id	xs:ID	optional			
source	<code><xs:element name="KeyInfo" type="ds:KeyInfoType"/></code>					

element **KeyName**

diagram						
namespace	http://www.w3.org/2000/09/xmldsig#					
type	xs:string					
properties	content	simple				
used by	complexType	KeyInfoType				
source	<code><xs:element name="KeyName" type="string"/></code>					

element **KeyValue**

diagram	
namespace	http://www.w3.org/2000/09/xmldsig#
type	ds:KeyValue
properties	content complex mixed true
children	ds:DSAKeyValue ds:RSAKeyValue
used by	complexType KeyInfoType
source	<code><xs:element name="KeyValue" type="ds:KeyValueType"/></code>

element **Manifest**

diagram													
namespace	http://www.w3.org/2000/09/xmldsig#												
type	ds:Manifest												
properties	content complex												
children	ds:Reference												
attributes	<table border="1"> <thead> <tr> <th>Name</th> <th>Type</th> <th>Use</th> <th>Default</th> <th>Fixed</th> <th>Annotation</th> </tr> </thead> <tbody> <tr> <td>Id</td> <td>xs:ID</td> <td>optional</td> <td></td> <td></td> <td></td> </tr> </tbody> </table>	Name	Type	Use	Default	Fixed	Annotation	Id	xs:ID	optional			
Name	Type	Use	Default	Fixed	Annotation								
Id	xs:ID	optional											
source	<code><xs:element name="Manifest" type="ds:ManifestType"/></code>												

element **MgmtData**

diagram	
namespace	http://www.w3.org/2000/09/xmldsig#
type	xs:string

properties	content simple
used by	complexType KeyInfoType
source	<code><xs:element name="MgmtData" type="string"/></code>

element Object

diagram						
namespace	http://www.w3.org/2000/09/xmldsig#					
type	ds:ObjectType					
properties	content complex					
	mixed true					
used by	complexType SignatureType					
attributes	Name	Type	Use	Default	Fixed	Annotation
	Id	xs:ID	optional			
	MimeType	xs:string	optional			
	Encoding	xs:anyURI	optional			
source	<code><xs:element name="Object" type="ds:ObjectType"/></code>					

element PGPDData

diagram						
---------	--	--	--	--	--	--

namespace	http://www.w3.org/2000/09/xmldsig#
type	ds:PGPDataType
properties	content complex
children	ds:PGPKeyID ds:PGPKeyPacket ds:PGPKeyPacket
used by	complexType KeyInfoType
source	<code><xs:element name="PGPData" type="ds:PGPDataType"/></code>

element Reference

diagram						
namespace	http://www.w3.org/2000/09/xmldsig#					
type	ds:ReferenceType					
properties	content complex					
children	ds:Transforms ds:DigestMethod ds:DigestValue					
used by	complexTypes ManifestType SignedInfoType					
attributes	Name	Type	Use	Default	Fixed	Annotation
	Id	xs:ID	optional			
	URI	xs:anyURI	optional			
	Type	xs:anyURI	optional			
source	<code><xs:element name="Reference" type="ds:ReferenceType"/></code>					

element RetrievalMethod

diagram						
namespace	http://www.w3.org/2000/09/xmldsig#					
type	ds:RetrievalMethodType					
properties	content complex					
children	ds:Transforms					
used by	complexType KeyInfoType					
attributes	Name	Type	Use	Default	Fixed	Annotation
	URI	xs:anyURI				
	Type	xs:anyURI	optional			
source	<code><xs:element name="RetrievalMethod" type="ds:RetrievalMethodType"/></code>					

element RSAKeyValue

diagram						
namespace	http://www.w3.org/2000/09/xmldsig#					
type	ds:RSAKeyValue Type					
properties	content complex					
children	ds:Modulus ds:Exponent					
used by	complexType KeyValue Type					
source	<code><xs:element name="RSAKeyValue" type="ds:RSAKeyValue Type"/></code>					

element **Signature**

diagram						
namespace	http://www.w3.org/2000/09/xmldsig#					
type	ds:SignatureType					
properties	content complex					
children	ds:SignedInfo ds:SignatureValue ds:KeyInfo ds:Object					
used by	element MensajeReceptor					
attributes	Name	Type	Use	Default	Fixed	Annotation
	Id	xs:ID	optional			
source	<code><xs:element name="Signature" type="ds:SignatureType"/></code>					

element **SignatureMethod**

diagram						
namespace	http://www.w3.org/2000/09/xmldsig#					
type	ds:SignatureMethodType					
properties	content complex mixed true					
children	ds:HMACOutputLength					
used by	complexType SignedInfoType					

attributes	Name Algorithm	Type xs:anyURI	Use required	Default	Fixed	Annotation
source	<code><xs:element name="SignatureMethod" type="ds:SignatureMethodType"/></code>					

element SignatureProperties

diagram	<p>The diagram shows a box labeled 'SignatureProperties' connected to a larger box labeled 'ds:SignaturePropertiesType'. Inside this box, there is an 'attributes' container with an 'Id' attribute. Below the attributes is a sequence of 'ds:SignatureProperty' elements, indicated by a plus sign and the cardinality '1..∞'.</p>					
namespace	http://www.w3.org/2000/09/xmldsig#					
type	ds:SignaturePropertiesType					
properties	content complex					
children	ds:SignatureProperty					
attributes	Name Id	Type xs:ID	Use optional	Default	Fixed	Annotation
source	<code><xs:element name="SignatureProperties" type="ds:SignaturePropertiesType"/></code>					

element SignatureProperty

diagram	<p>The diagram shows a box labeled 'SignatureProperty' connected to a larger box labeled 'ds:SignaturePropertyType'. Inside this box, there is an 'attributes' container with 'Target' and 'Id' attributes. Below the attributes is a sequence of 'any ##other' elements, indicated by a plus sign and the cardinality '1..∞'.</p>					
namespace	http://www.w3.org/2000/09/xmldsig#					
type	ds:SignaturePropertyType					
properties	content complex mixed true					
used by	complexType SignaturePropertiesType					
attributes	Name Target	Type xs:anyURI	Use required	Default	Fixed	Annotation
	Id	xs:ID	optional			

source	<code><xs:element name="SignatureProperty" type="ds:SignaturePropertyType"/></code>
--------	---

element **SignatureValue**

diagram						
namespace	http://www.w3.org/2000/09/xmldsig#					
type	ds:SignatureValueType					
properties	content complex					
used by	complexType SignatureType					
attributes	Name	Type	Use	Default	Fixed	Annotation
	Id	xs:ID	optional			
source	<code><xs:element name="SignatureValue" type="ds:SignatureValueType"/></code>					

element **SignedInfo**

diagram						
namespace	http://www.w3.org/2000/09/xmldsig#					
type	ds:SignedInfoType					
properties	content complex					
children	ds:CanonicalizationMethod ds:SignatureMethod ds:Reference					
used by	complexType SignatureType					
attributes	Name	Type	Use	Default	Fixed	Annotation
	Id	xs:ID	optional			
source	<code><xs:element name="SignedInfo" type="ds:SignedInfoType"/></code>					

element SPKIData

diagram	
namespace	http://www.w3.org/2000/09/xmldsig#
type	ds:SPKIDataType
properties	content complex
children	ds:SPKISexp
used by	complexType KeyInfoType
source	<code><xs:element name="SPKIData" type="ds:SPKIDataType"/></code>

element Transform

diagram													
namespace	http://www.w3.org/2000/09/xmldsig#												
type	ds:TransformType												
properties	content complex mixed true												
children	ds:XPath												
used by	complexType TransformsType												
attributes	<table border="1"> <thead> <tr> <th>Name</th> <th>Type</th> <th>Use</th> <th>Default</th> <th>Fixed</th> <th>Annotation</th> </tr> </thead> <tbody> <tr> <td>Algorithm</td> <td>xs:anyURI</td> <td>required</td> <td></td> <td></td> <td></td> </tr> </tbody> </table>	Name	Type	Use	Default	Fixed	Annotation	Algorithm	xs:anyURI	required			
Name	Type	Use	Default	Fixed	Annotation								
Algorithm	xs:anyURI	required											
source	<code><xs:element name="Transform" type="ds:TransformType"/></code>												

element **Transforms**

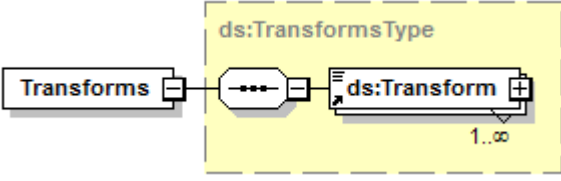
diagram	 <p>The diagram shows the structure of the <code>ds:TransformsType</code> element. It consists of a <code>Transforms</code> element (represented by a box with a plus sign) connected to a sequence container (represented by a box with three dots). This sequence container is enclosed in a dashed yellow box labeled <code>ds:TransformsType</code>. Inside this box, there is a <code>ds:Transform</code> element (represented by a box with a plus sign) and a cardinality of <code>1..∞</code> below it, indicating that one or more <code>ds:Transform</code> elements are allowed.</p>
namespace	http://www.w3.org/2000/09/xmldsig#
type	ds:TransformsType
properties	content complex
children	ds:Transform
used by	complexTypees ReferenceType RetrievalMethodType
source	<code><xs:element name="Transforms" type="ds:TransformsType"/></code>

element **X509Data**

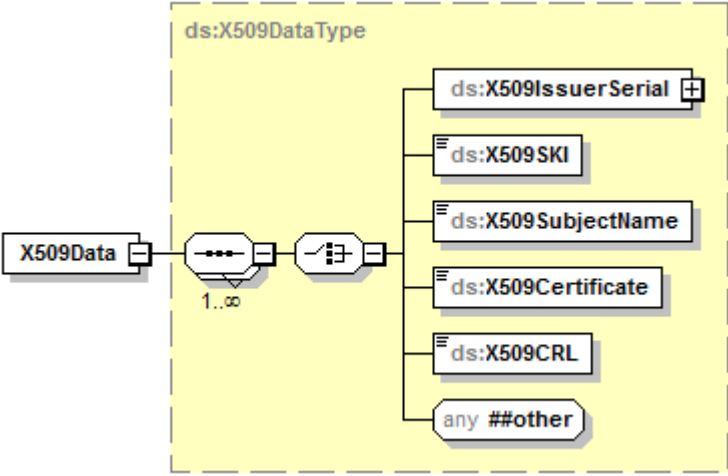
diagram	 <p>The diagram shows the structure of the <code>ds:X509DataType</code> element. It consists of an <code>X509Data</code> element (represented by a box with a plus sign) connected to a sequence container (represented by a box with three dots). This sequence container is enclosed in a dashed yellow box labeled <code>ds:X509DataType</code>. Below the sequence container is a cardinality of <code>1..∞</code>. The sequence container is followed by a choice container (represented by a box with a plus sign). This choice container contains several child elements: <code>ds:X509IssuerSerial</code> (box with plus sign), <code>ds:X509SKI</code> (box with equals sign), <code>ds:X509SubjectName</code> (box with equals sign), <code>ds:X509Certificate</code> (box with equals sign), <code>ds:X509CRL</code> (box with equals sign), and <code>any ##other</code> (box with equals sign).</p>
namespace	http://www.w3.org/2000/09/xmldsig#
type	ds:X509DataType
properties	content complex
children	ds:X509IssuerSerial ds:X509SKI ds:X509SubjectName ds:X509Certificate ds:X509CRL
used by	complexType KeyInfoType
source	<code><xs:element name="X509Data" type="ds:X509DataType"/></code>

complexType CanonicalizationMethodType

diagram						
namespace	http://www.w3.org/2000/09/xmldsig#					
properties	mixed true					
used by	element CanonicalizationMethod					
attributes	Name	Type	Use	Default	Fixed	Annotation
	Algorithm	xs:anyURI	required			
source	<pre><xs:complexType name="CanonicalizationMethodType" mixed="true"> <xs:sequence> <xs:any namespace="##any" minOccurs="0" maxOccurs="unbounded"/> <!-- (0,unbounded) elements from (1,1) namespace --> </xs:sequence> <xs:attribute name="Algorithm" type="anyURI" use="required"/> </xs:complexType></pre>					

attribute CanonicalizationMethodType/@Algorithm

type	xs:anyURI
properties	use required
source	<pre><xs:attribute name="Algorithm" type="anyURI" use="required"/></pre>

complexType DigestMethodType

diagram						
namespace	http://www.w3.org/2000/09/xmldsig#					
properties	mixed true					
used by	element DigestMethod					
attributes	Name	Type	Use	Default	Fixed	Annotation
	Algorithm	xs:anyURI	required			
source	<pre><xs:complexType name="DigestMethodType" mixed="true"> <xs:sequence> <xs:any namespace="##other" processContents="lax" minOccurs="0" maxOccurs="unbounded"/> </xs:sequence> </xs:complexType></pre>					

```

</xs:sequence>
<xs:attribute name="Algorithm" type="anyURI" use="required"/>
</xs:complexType>

```

attribute **DigestMethodType/@Algorithm**

type	xs:anyURI
properties	use required
source	<xs:attribute name="Algorithm" type="anyURI" use="required"/>

complexType **DSAKeyValue**

diagram	
namespace	http://www.w3.org/2000/09/xmldsig#
children	ds:P ds:Q ds:G ds:Y ds:J ds:Seed ds:PgenCounter
used by	element DSAKeyValue
source	<pre> <xs:complexType name="DSAKeyValue"> <xs:sequence> <xs:sequence minOccurs="0"> <xs:element name="P" type="ds:CryptoBinary"/> <xs:element name="Q" type="ds:CryptoBinary"/> </xs:sequence> <xs:element name="G" type="ds:CryptoBinary" minOccurs="0"/> <xs:element name="Y" type="ds:CryptoBinary"/> <xs:element name="J" type="ds:CryptoBinary" minOccurs="0"/> <xs:sequence minOccurs="0"> <xs:element name="Seed" type="ds:CryptoBinary"/> <xs:element name="PgenCounter" type="ds:CryptoBinary"/> </xs:sequence> </xs:sequence> </xs:complexType> </pre>

element **DSAKeyValue**Type/P

diagram	
namespace	http://www.w3.org/2000/09/xmldsig#
type	ds:CryptBinary
properties	content simple
source	<code><xs:element name="P" type="ds:CryptBinary"/></code>

element **DSAKeyValue**Type/Q

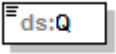
diagram	
namespace	http://www.w3.org/2000/09/xmldsig#
type	ds:CryptBinary
properties	content simple
source	<code><xs:element name="Q" type="ds:CryptBinary"/></code>

element **DSAKeyValue**Type/G

diagram	
namespace	http://www.w3.org/2000/09/xmldsig#
type	ds:CryptBinary
properties	minOcc 0 maxOcc 1 content simple
source	<code><xs:element name="G" type="ds:CryptBinary" minOccurs="0"/></code>

element **DSAKeyValue**Type/Y

diagram	
namespace	http://www.w3.org/2000/09/xmldsig#
type	ds:CryptBinary
properties	content simple
source	<code><xs:element name="Y" type="ds:CryptBinary"/></code>

element **DSAKeyValue**Type/J

diagram	
---------	---

namespace	http://www.w3.org/2000/09/xmldsig#
type	ds:CryptoBinary
properties	minOcc 0 maxOcc 1 content simple
source	<code><xs:element name="J" type="ds:CryptoBinary" minOccurs="0"/></code>

element DSAKeyValue/Seed

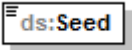
diagram	 A diagram showing a rectangular box with a small icon on the left and the text "ds:Seed" inside.
namespace	http://www.w3.org/2000/09/xmldsig#
type	ds:CryptoBinary
properties	content simple
source	<code><xs:element name="Seed" type="ds:CryptoBinary"/></code>

element DSAKeyValue/PgenCounter

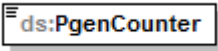
diagram	 A diagram showing a rectangular box with a small icon on the left and the text "ds:PgenCounter" inside.
namespace	http://www.w3.org/2000/09/xmldsig#
type	ds:CryptoBinary
properties	content simple
source	<code><xs:element name="PgenCounter" type="ds:CryptoBinary"/></code>

complexType KeyInfoType

diagram							
namespace	http://www.w3.org/2000/09/xmldsig#						
properties	mixed true						
children	ds:KeyName ds:KeyValue ds:RetrievalMethod ds:X509Data ds:PGPData ds:SPKIData ds:MgmtData						
used by	element KeyInfo						
attributes	Name	Type	Use	Default	Fixed	Annotation	
	Id	xs:ID	optional				
source	<pre> <xs:complexType name="KeyInfoType" mixed="true"> <xs:choice maxOccurs="unbounded"> <xs:element ref="ds:KeyName"/> <xs:element ref="ds:KeyValue"/> <xs:element ref="ds:RetrievalMethod"/> <xs:element ref="ds:X509Data"/> <xs:element ref="ds:PGPData"/> <xs:element ref="ds:SPKIData"/> <xs:element ref="ds:MgmtData"/> <xs:any namespace="##other" processContents="lax"/> <!-- (1,1) elements from (0,unbounded) namespaces --> </xs:choice> <xs:attribute name="Id" type="ID" use="optional"/> </xs:complexType> </pre>						

attribute KeyInfoType/@Id

type	xs:ID
properties	use optional
source	<code><xs:attribute name="Id" type="ID" use="optional"/></code>

complexType KeyValue

diagram	
namespace	http://www.w3.org/2000/09/xmldsig#
properties	mixed true
children	ds:DSAKeyValue ds:RSAKeyValue
used by	element KeyValue
source	<pre><xs:complexType name="KeyValue" mixed="true"> <xs:choice> <xs:element ref="ds:DSAKeyValue"/> <xs:element ref="ds:RSAKeyValue"/> <xs:any namespace="##other" processContents="lax"/> </xs:choice> </xs:complexType></pre>

complexType Manifest

diagram													
namespace	http://www.w3.org/2000/09/xmldsig#												
children	ds:Reference												
used by	element Manifest												
attributes	<table border="1"> <thead> <tr> <th>Name</th> <th>Type</th> <th>Use</th> <th>Default</th> <th>Fixed</th> <th>Annotation</th> </tr> </thead> <tbody> <tr> <td>Id</td> <td>xs:ID</td> <td>optional</td> <td></td> <td></td> <td></td> </tr> </tbody> </table>	Name	Type	Use	Default	Fixed	Annotation	Id	xs:ID	optional			
Name	Type	Use	Default	Fixed	Annotation								
Id	xs:ID	optional											
source	<pre><xs:complexType name="Manifest"> <xs:sequence> <xs:element ref="ds:Reference" maxOccurs="unbounded"/> </xs:sequence> <xs:attribute name="Id" type="ID" use="optional"/> </xs:complexType></pre>												

attribute Manifest/@Id

type	xs:ID
properties	use optional

source	<code><xs:attribute name="Id" type="ID" use="optional"/></code>
--------	---

complexType ObjectType

diagram																									
namespace	http://www.w3.org/2000/09/xmldsig#																								
properties	mixed true																								
used by	element Object																								
attributes	<table border="1"> <thead> <tr> <th>Name</th> <th>Type</th> <th>Use</th> <th>Default</th> <th>Fixed</th> <th>Annotation</th> </tr> </thead> <tbody> <tr> <td>Id</td> <td>xs:ID</td> <td>optional</td> <td></td> <td></td> <td></td> </tr> <tr> <td>MimeType</td> <td>xs:string</td> <td>optional</td> <td></td> <td></td> <td></td> </tr> <tr> <td>Encoding</td> <td>xs:anyURI</td> <td>optional</td> <td></td> <td></td> <td></td> </tr> </tbody> </table>	Name	Type	Use	Default	Fixed	Annotation	Id	xs:ID	optional				MimeType	xs:string	optional				Encoding	xs:anyURI	optional			
Name	Type	Use	Default	Fixed	Annotation																				
Id	xs:ID	optional																							
MimeType	xs:string	optional																							
Encoding	xs:anyURI	optional																							
source	<pre> <xs:complexType name="ObjectType" mixed="true"> <xs:sequence minOccurs="0" maxOccurs="unbounded"> <xs:any namespace="##any" processContents="lax"/> </xs:sequence> <xs:attribute name="Id" type="ID" use="optional"/> <xs:attribute name="MimeType" type="string" use="optional"/> <xs:attribute name="Encoding" type="anyURI" use="optional"/> <!-- add a grep facet --> </xs:complexType> </pre>																								

attribute ObjectType/@Id

type	xs:ID
properties	use optional
source	<code><xs:attribute name="Id" type="ID" use="optional"/></code>

attribute ObjectType/@MimeType

type	xs:string
properties	use optional
source	<code><xs:attribute name="MimeType" type="string" use="optional"/></code>

attribute **ObjectType/@Encoding**

type	xs:anyURI
properties	use optional
source	<xs:attribute name="Encoding" type="anyURI" use="optional"/>

complexType **PGPDataType**

diagram	
namespace	http://www.w3.org/2000/09/xmldsig#
children	ds:PGPKeyID ds:PGPKeyPacket ds:PGPKeyPacket
used by	element PGPData
source	<pre> <xs:complexType name="PGPDataType"> <xs:choice> <xs:sequence> <xs:element name="PGPKeyID" type="base64Binary"/> <xs:element name="PGPKeyPacket" type="base64Binary" minOccurs="0"/> <xs:any namespace="##other" processContents="lax" minOccurs="0" maxOccurs="unbounded"/> </xs:sequence> <xs:sequence> <xs:element name="PGPKeyPacket" type="base64Binary"/> <xs:any namespace="##other" processContents="lax" minOccurs="0" maxOccurs="unbounded"/> </xs:sequence> </xs:choice> </xs:complexType> </pre>

element **PGPDataType/PGPKeyID**

diagram	
namespace	http://www.w3.org/2000/09/xmldsig#
type	xs:base64Binary
properties	content simple
source	<xs:element name="PGPKeyID" type="base64Binary"/>

element **PGPDataType/PGPKeyPacket**

diagram	
namespace	http://www.w3.org/2000/09/xmldsig#
type	xs:base64Binary
properties	minOcc 0 maxOcc 1 content simple
source	<code><xs:element name="PGPKeyPacket" type="base64Binary" minOccurs="0"/></code>

element **PGPDataType/PGPKeyPacket**

diagram	
namespace	http://www.w3.org/2000/09/xmldsig#
type	xs:base64Binary
properties	content simple
source	<code><xs:element name="PGPKeyPacket" type="base64Binary"/></code>

complexType **ReferenceType**

diagram						
namespace	http://www.w3.org/2000/09/xmldsig#					
children	ds:Transforms ds:DigestMethod ds:DigestValue					
used by	element Reference					
attributes	Name	Type	Use	Default	Fixed	Annotation
	Id	xs:ID	optional			
	URI	xs:anyURI	optional			
	Type	xs:anyURI	optional			
source	<code><xs:complexType name="ReferenceType"></code>					

```

<xs:sequence>
  <xs:element ref="ds:Transforms" minOccurs="0"/>
  <xs:element ref="ds:DigestMethod"/>
  <xs:element ref="ds:DigestValue"/>
</xs:sequence>
<xs:attribute name="Id" type="ID" use="optional"/>
<xs:attribute name="URI" type="anyURI" use="optional"/>
<xs:attribute name="Type" type="anyURI" use="optional"/>
</xs:complexType>

```

attribute **ReferenceType/@Id**

type	xs:ID
properties	use optional
source	<code><xs:attribute name="Id" type="ID" use="optional"/></code>

attribute **ReferenceType/@URI**

type	xs:anyURI
properties	use optional
source	<code><xs:attribute name="URI" type="anyURI" use="optional"/></code>

attribute **ReferenceType/@Type**

type	xs:anyURI
properties	use optional
source	<code><xs:attribute name="Type" type="anyURI" use="optional"/></code>

complexType **RetrievalMethodType**

diagram						
namespace	http://www.w3.org/2000/09/xmldsig#					
children	ds:Transforms					
used by	element	RetrievalMethod				
attributes	Name	Type	Use	Default	Fixed	Annotation
	URI	xs:anyURI				
	Type	xs:anyURI	optional			

source	<pre><xs:complexType name="RetrievalMethodType"> <xs:sequence> <xs:element ref="ds:Transforms" minOccurs="0"/> </xs:sequence> <xs:attribute name="URI" type="anyURI"/> <xs:attribute name="Type" type="anyURI" use="optional"/> </xs:complexType></pre>
--------	---

attribute RetrievalMethodType/@URI

type	xs:anyURI
source	<xs:attribute name="URI" type="anyURI"/>

attribute RetrievalMethodType/@Type

type	xs:anyURI
properties	use optional
source	<xs:attribute name="Type" type="anyURI" use="optional"/>

complexType RSAKeyValue

diagram	
namespace	http://www.w3.org/2000/09/xmldsig#
children	ds:Modulus ds:Exponent
used by	element RSAKeyValue
source	<pre><xs:complexType name="RSAKeyValue"> <xs:sequence> <xs:element name="Modulus" type="ds:CryptoBinary"/> <xs:element name="Exponent" type="ds:CryptoBinary"/> </xs:sequence> </xs:complexType></pre>

element RSAKeyValue/Modulus

diagram	
namespace	http://www.w3.org/2000/09/xmldsig#
type	ds:CryptoBinary
properties	content simple
source	<xs:element name="Modulus" type="ds:CryptoBinary"/>

element RSAKeyValue/Exponent

diagram	
namespace	http://www.w3.org/2000/09/xmldsig#
type	ds:CryptoBinary
properties	content simple
source	<code><xs:element name="Exponent" type="ds:CryptoBinary"/></code>

complexType SignatureMethodType

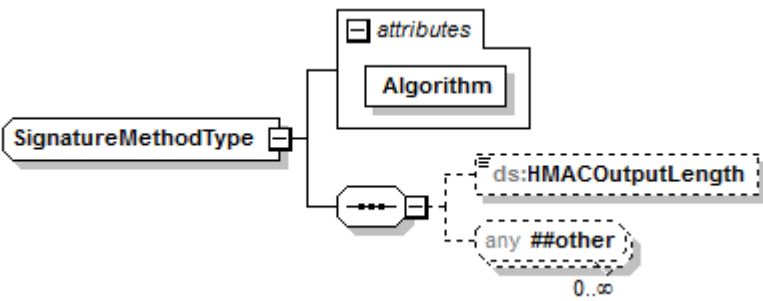
diagram													
namespace	http://www.w3.org/2000/09/xmldsig#												
properties	mixed true												
children	ds:HMACOutputLength												
used by	element SignatureMethod												
attributes	<table border="1"> <thead> <tr> <th>Name</th> <th>Type</th> <th>Use</th> <th>Default</th> <th>Fixed</th> <th>Annotation</th> </tr> </thead> <tbody> <tr> <td>Algorithm</td> <td>xs:anyURI</td> <td>required</td> <td></td> <td></td> <td></td> </tr> </tbody> </table>	Name	Type	Use	Default	Fixed	Annotation	Algorithm	xs:anyURI	required			
Name	Type	Use	Default	Fixed	Annotation								
Algorithm	xs:anyURI	required											
source	<pre> <xs:complexType name="SignatureMethodType" mixed="true"> <xs:sequence> <xs:element name="HMACOutputLength" type="ds:HMACOutputLengthType" minOccurs="0"/> <xs:any namespace="##other" minOccurs="0" maxOccurs="unbounded"/> <!-- (0,unbounded) elements from (1,1) external namespace --> </xs:sequence> <xs:attribute name="Algorithm" type="anyURI" use="required"/> </xs:complexType> </pre>												

attribute SignatureMethodType/@Algorithm

type	xs:anyURI
properties	use required
source	<code><xs:attribute name="Algorithm" type="anyURI" use="required"/></code>

element **SignatureMethodType/HMACOutputLength**

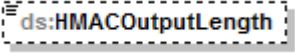
diagram	
namespace	http://www.w3.org/2000/09/xmldsig#
type	ds:HMACOutputLengthType
properties	minOcc 0 maxOcc 1 content simple
source	<code><xs:element name="HMACOutputLength" type="ds:HMACOutputLengthType" minOccurs="0"/></code>

complexType **SignaturePropertiesType**

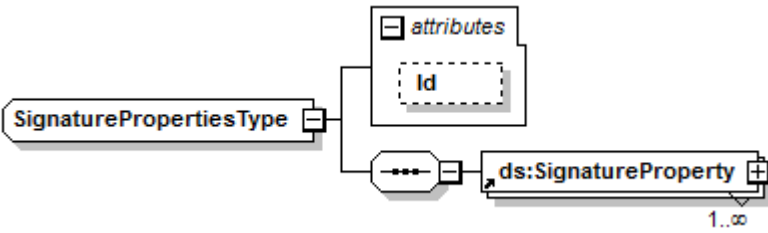
diagram													
namespace	http://www.w3.org/2000/09/xmldsig#												
children	ds:SignatureProperty												
used by	element SignatureProperties												
attributes	<table border="1"> <thead> <tr> <th>Name</th> <th>Type</th> <th>Use</th> <th>Default</th> <th>Fixed</th> <th>Annotation</th> </tr> </thead> <tbody> <tr> <td>Id</td> <td>xs:ID</td> <td>optional</td> <td></td> <td></td> <td></td> </tr> </tbody> </table>	Name	Type	Use	Default	Fixed	Annotation	Id	xs:ID	optional			
Name	Type	Use	Default	Fixed	Annotation								
Id	xs:ID	optional											
source	<code><xs:complexType name="SignaturePropertiesType"> <xs:sequence> <xs:element ref="ds:SignatureProperty" maxOccurs="unbounded"/> </xs:sequence> <xs:attribute name="Id" type="ID" use="optional"/> </xs:complexType></code>												

attribute **SignaturePropertiesType/@Id**

type	xs:ID
properties	use optional
source	<code><xs:attribute name="Id" type="ID" use="optional"/></code>

complexType **SignaturePropertyType**

diagram						
namespace	http://www.w3.org/2000/09/xmldsig#					
properties	mixed true					
used by	element SignatureProperty					
attributes	Name	Type	Use	Default	Fixed	Annotation
	Target	xs:anyURI	required			
	Id	xs:ID	optional			
source	<pre><xs:complexType name="SignaturePropertyType" mixed="true"> <xs:choice maxOccurs="unbounded"> <xs:any namespace="##other" processContents="lax"/> <!-- (1,1) elements from (1,unbounded) namespaces --> </xs:choice> <xs:attribute name="Target" type="anyURI" use="required"/> <xs:attribute name="Id" type="ID" use="optional"/> </xs:complexType></pre>					

attribute **SignaturePropertyType/@Target**

type	xs:anyURI
properties	use required
source	<pre><xs:attribute name="Target" type="anyURI" use="required"/></pre>

attribute **SignaturePropertyType/@Id**

type	xs:ID
properties	use optional
source	<pre><xs:attribute name="Id" type="ID" use="optional"/></pre>

complexType **SignatureType**

diagram						
namespace	http://www.w3.org/2000/09/xmldsig#					
children	ds:SignedInfo ds:SignatureValue ds:KeyInfo ds:Object					
used by	element Signature					
attributes	Name	Type	Use	Default	Fixed	Annotation
	Id	xs:ID	optional			
source	<pre> <xs:complexType name="SignatureType"> <xs:sequence> <xs:element ref="ds:SignedInfo"/> <xs:element ref="ds:SignatureValue"/> <xs:element ref="ds:KeyInfo" minOccurs="0"/> <xs:element ref="ds:Object" minOccurs="0" maxOccurs="unbounded"/> </xs:sequence> <xs:attribute name="Id" type="ID" use="optional"/> </xs:complexType> </pre>					

attribute **SignatureType/@Id**

type	xs:ID
properties	use optional
source	<code><xs:attribute name="Id" type="ID" use="optional"/></code>

complexType **SignatureValueType**

diagram						
namespace	http://www.w3.org/2000/09/xmldsig#					
type	extension of xs:base64Binary					
properties	base base64Binary					
used by	element SignatureValue					

attributes	Name <u>Id</u>	Type xs:ID	Use optional	Default	Fixed	Annotation
source	<pre><xs:complexType name="SignatureValueType"> <xs:simpleContent> <xs:extension base="base64Binary"> <xs:attribute name="Id" type="ID" use="optional"/> </xs:extension> </xs:simpleContent> </xs:complexType></pre>					

attribute **SignatureValueType/@Id**

type	xs:ID
properties	use optional
source	<pre><xs:attribute name="Id" type="ID" use="optional"/></pre>

complexType **SignedInfoType**

diagram													
namespace	http://www.w3.org/2000/09/xmldsig#												
children	ds:CanonicalizationMethod ds:SignatureMethod ds:Reference												
used by	element SignedInfo												
attributes	<table border="1"> <thead> <tr> <th>Name</th> <th>Type</th> <th>Use</th> <th>Default</th> <th>Fixed</th> <th>Annotation</th> </tr> </thead> <tbody> <tr> <td><u>Id</u></td> <td>xs:ID</td> <td>optional</td> <td></td> <td></td> <td></td> </tr> </tbody> </table>	Name	Type	Use	Default	Fixed	Annotation	<u>Id</u>	xs:ID	optional			
Name	Type	Use	Default	Fixed	Annotation								
<u>Id</u>	xs:ID	optional											
source	<pre><xs:complexType name="SignedInfoType"> <xs:sequence> <xs:element ref="ds:CanonicalizationMethod"/> <xs:element ref="ds:SignatureMethod"/> <xs:element ref="ds:Reference" maxOccurs="unbounded"/> </xs:sequence> <xs:attribute name="Id" type="ID" use="optional"/> </xs:complexType></pre>												

attribute **SignedInfoType/@Id**

type	xs:ID
------	--------------

properties	use optional
source	<code><xs:attribute name="Id" type="ID" use="optional"/></code>

complexType SPKIDataType

diagram	
namespace	http://www.w3.org/2000/09/xmldsig#
children	ds:SPKISexp
used by	element SPKIData
source	<pre> <xs:complexType name="SPKIDataType"> <xs:sequence maxOccurs="unbounded"> <xs:element name="SPKISexp" type="base64Binary"/> <xs:any namespace="##other" processContents="lax" minOccurs="0"/> </xs:sequence> </xs:complexType> </pre>

element SPKIDataType/SPKISexp

diagram	
namespace	http://www.w3.org/2000/09/xmldsig#
type	xs:base64Binary
properties	content simple
source	<code><xs:element name="SPKISexp" type="base64Binary"/></code>

complexType TransformsType

diagram	
namespace	http://www.w3.org/2000/09/xmldsig#
children	ds:Transform
used by	element Transforms
source	<pre> <xs:complexType name="TransformsType"> <xs:sequence> <xs:element ref="ds:Transform" maxOccurs="unbounded"/> </xs:sequence> </xs:complexType> </pre>

complexType TransformType

diagram						
namespace	http://www.w3.org/2000/09/xmldsig#					
properties	mixed true					
children	ds:XPath					
used by	element Transform					
attributes	Name	Type	Use	Default	Fixed	Annotation
	Algorithm	xs:anyURI	required			
source	<pre> <xs:complexType name="TransformType" mixed="true"> <xs:choice minOccurs="0" maxOccurs="unbounded"> <xs:any namespace="##other" processContents="lax"/> <!-- (1,1) elements from (0,unbounded) namespaces --> <xs:element name="XPath" type="string"/> </xs:choice> <xs:attribute name="Algorithm" type="anyURI" use="required"/> </xs:complexType> </pre>					

attribute TransformType/@Algorithm

type	xs:anyURI
properties	use required
source	<pre><xs:attribute name="Algorithm" type="anyURI" use="required"/></pre>

element TransformType/XPath

diagram						
namespace	http://www.w3.org/2000/09/xmldsig#					
type	xs:string					
properties	content simple					
source	<pre><xs:element name="XPath" type="string"/></pre>					

complexType X509DataType

diagram	
namespace	http://www.w3.org/2000/09/xmldsig#
children	ds:X509IssuerSerial ds:X509SKI ds:X509SubjectName ds:X509Certificate ds:X509CRL
used by	element X509Data
source	<pre> <xs:complexType name="X509DataType"> <xs:sequence maxOccurs="unbounded"> <xs:choice> <xs:element name="X509IssuerSerial" type="ds:X509IssuerSerialType"/> <xs:element name="X509SKI" type="base64Binary"/> <xs:element name="X509SubjectName" type="string"/> <xs:element name="X509Certificate" type="base64Binary"/> <xs:element name="X509CRL" type="base64Binary"/> <xs:any namespace="##other" processContents="lax"/> </xs:choice> </xs:sequence> </xs:complexType> </pre>

element X509DataType/X509IssuerSerial

diagram	
namespace	http://www.w3.org/2000/09/xmldsig#
type	ds:X509IssuerSerialType
properties	content complex
children	ds:X509IssuerName ds:X509SerialNumber
source	<pre> <xs:element name="X509IssuerSerial" type="ds:X509IssuerSerialType"/> </pre>

element X509DataType/X509SKI

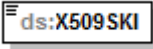
diagram	
namespace	http://www.w3.org/2000/09/xmldsig#
type	xs:base64Binary
properties	content simple
source	<code><xs:element name="X509SKI" type="base64Binary"/></code>

element X509DataType/X509SubjectName

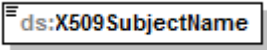
diagram	
namespace	http://www.w3.org/2000/09/xmldsig#
type	xs:string
properties	content simple
source	<code><xs:element name="X509SubjectName" type="string"/></code>

element X509DataType/X509Certificate

diagram	
namespace	http://www.w3.org/2000/09/xmldsig#
type	xs:base64Binary
properties	content simple
source	<code><xs:element name="X509Certificate" type="base64Binary"/></code>

element X509DataType/X509CRL

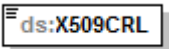
diagram	
namespace	http://www.w3.org/2000/09/xmldsig#
type	xs:base64Binary
properties	content simple
source	<code><xs:element name="X509CRL" type="base64Binary"/></code>

complexType X509IssuerSerialType

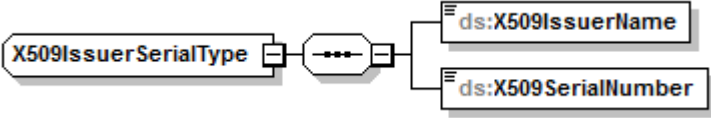
diagram	
namespace	http://www.w3.org/2000/09/xmldsig#
children	ds:X509IssuerName ds:X509SerialNumber
used by	element X509DataType/X509IssuerSerial
source	<pre><xs:complexType name="X509IssuerSerialType"> <xs:sequence> <xs:element name="X509IssuerName" type="string"/> <xs:element name="X509SerialNumber" type="integer"/> </xs:sequence> </xs:complexType></pre>

element X509IssuerSerialType/X509IssuerName

diagram	
namespace	http://www.w3.org/2000/09/xmldsig#
type	xs:string
properties	content simple
source	<pre><xs:element name="X509IssuerName" type="string"/></pre>

element X509IssuerSerialType/X509SerialNumber

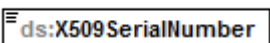
diagram	
namespace	http://www.w3.org/2000/09/xmldsig#
type	xs:integer
properties	content simple
source	<pre><xs:element name="X509SerialNumber" type="integer"/></pre>

simpleType CryptoBinary

namespace	http://www.w3.org/2000/09/xmldsig#
type	xs:base64Binary
properties	base base64Binary
used by	elements RSAKeyValue/Exponent RSAKeyValue/Modulus DSAKeyValue/G DSAKeyValue/J DSAKeyValue/P DSAKeyValue/Q DSAKeyValue/Seed DSAKeyValue/Y
source	<pre><xs:simpleType name="CryptoBinary"> <xs:restriction base="base64Binary"/> </xs:simpleType></pre>

	<code></xs:simpleType></code>
--	-------------------------------------

simpleType **DigestValueType**

namespace	http://www.w3.org/2000/09/xmldsig#
type	xs:base64Binary
properties	base base64Binary
used by	element DigestValue
source	<pre><xs:simpleType name="DigestValueType"> <xs:restriction base="base64Binary"/> </xs:simpleType></pre>

simpleType **HMACOutputLengthType**

namespace	http://www.w3.org/2000/09/xmldsig#
type	xs:integer
properties	base integer
used by	element SignatureMethodType/HMACOutputLength
source	<pre><xs:simpleType name="HMACOutputLengthType"> <xs:restriction base="integer"/> </xs:simpleType></pre>